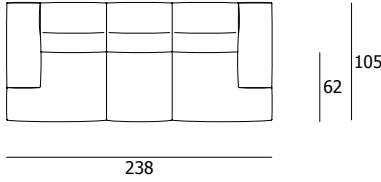
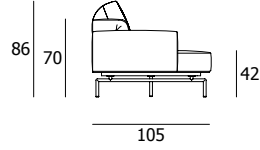
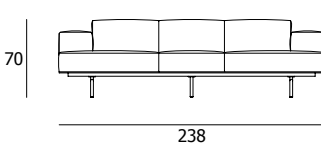
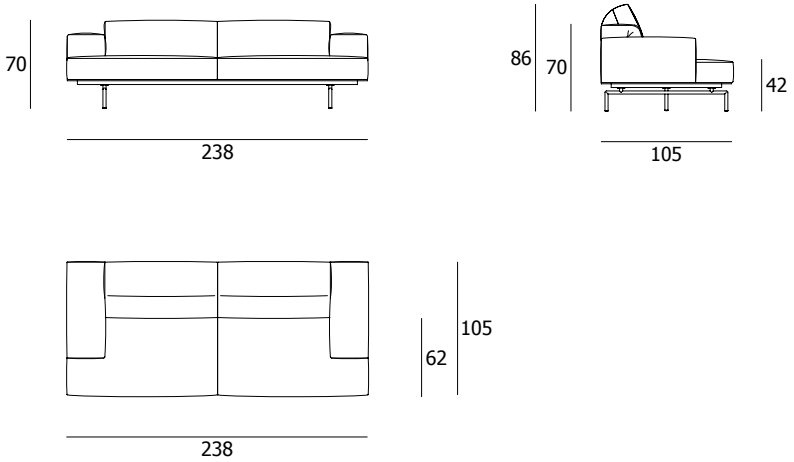
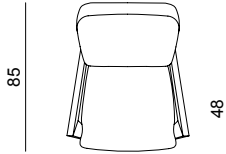
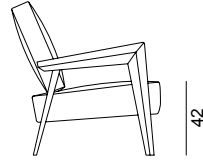
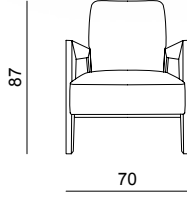

4 SEATER
4'LÜ KOLTUK

| Width / Genislik | Height / Yükseklik | Depth / Derinlik | Weight / Kilogram | m ³ |
|------------------|--------------------|------------------|-------------------|----------------|
| 238 cm | 70 cm | 105 cm | 95 Kg | 1,7 |

3 SEATER
3'LÜ KOLTUK

| Width / Genislik | Height / Yükseklik | Depth / Derinlik | Weight / Kilogram | m ³ |
|------------------|--------------------|------------------|-------------------|----------------|
| 238 cm | 86 cm | 105 cm | 80 Kg | 1.4 |

RITA BERGERE
RITA BERJER

| Width / Genislik | Height / Yükseklik | Depth / Derinlik | Weight / Kilogram | m ³ |
|------------------|--------------------|------------------|-------------------|----------------|
| 70 cm | 87 cm | 85 cm | 30 Kg | 0.5 |

FABRIC OPTIONS / KUMAS OPSİYONLARI

Category 1 / Kategori 1

HIPPO



001



20



30



40



50



170



330



340



380



410



440



530



600



670



680



690



750



COVERS

Fabric and leather colors can vary in shade from one batch to the next and, therefore, we cannot guarantee that the color will exactly match the set of fabric samples or pieces manufactured at a later date. Please understand, therefore, that colors on fabric samples or other media are given as a rough guide only. By confirming the order, the customer accepts said tolerances.

Kumaş ve deri renkleri bir partiden diğerine gölgede değişebilir ve bu nedenle rengin setle tam olarak eşleşeceğini garanti edemeyiz. kumaş numuneleri veya daha sonraki bir tarihte üretilmiş parçalar. Bu nedenle, kumaş numunelerindeki veya diğer ortamlardaki renklerin kaba olarak verildiğini lütfen anlayın. sadece rehber. Müşteri siparişi onaylayarak söz konusu toleransları kabul etmiş olur.

MEASUREMENTS

Given the technical properties of the sofa/ottoman and cushions, overall measurements given on the price list may have a tolerance of +/- 2 cm.

Kanepeler/dizgi ve minderlerin teknik özellikleri göz önüne alındığında, fiyat listesinde verilen genel ölçüler +/- 2 cm toleransa sahip olabilir.

RH AND LH ARMRESTS

In corner configurations, note that the position of the armrests (RH or LH) is as viewed from in front of the sofa.

Köşe Konfigurasyonlarında, kolçakların konumunun (sağ veya sol) kanepenin önünden görüldüğü gibi olduğuna dikkat edin.